



**UPPER
LEFT**

1



Substitute Shampoo Caddy Template

THE ONYX COLLECTION
Diamond
Wide Shower Caddy

1. Position Template on shower panel so it is between studs
2. Level Template using the level-line printed below
3. Trace shape onto shower panel
4. Protect panel face from tool scratches with tape
5. Cut shape out of panel using a fine blade jigsaw
6. Install caddy in hole with 100% pure adhesive silicone
7. Fill outside seam with colormatch silicone

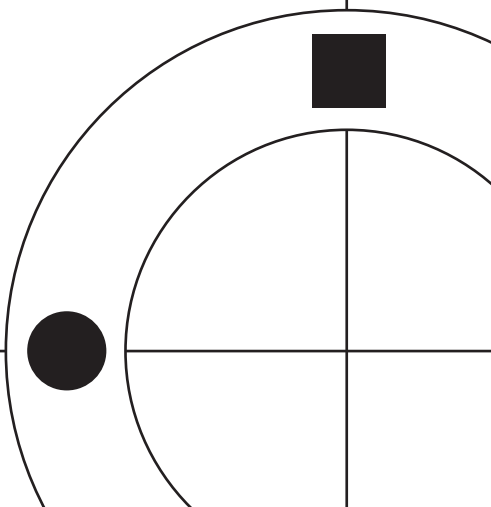
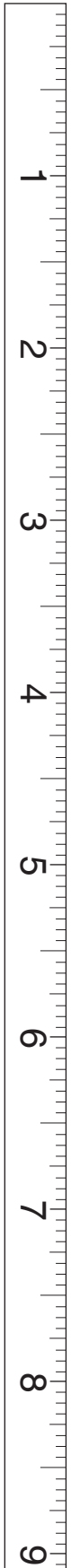
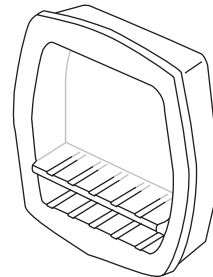

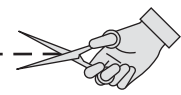

2

**UPPER
RIGHT**

The templates that come with our Soap and Shampoo Caddies are pre-cut cardboard shapes that are ready to be traced onto the wall to give you a guide for cutting your hole.

This substitute template in PDF format is offered online as an emergency replacement for a lost cardboard one, or to show the size and shape of the hole before the caddy arrives.

This template is too large to be printed on a single page, so you will need to print all the pages, tape or glue them together according to the alignment lines and marks, cut out the shape and trace it onto the wall, or just use it to help plan your installation.

When printing a PDF file, make sure the "Shrink" option and the "Expand" option are turned **off** in the printer dialog, and "Center" is turned on or you may get unexpected results. Make sure you print the whole document so you will have all the parts.

Rulers are shown along the perimeter to help you know if your printer made it the correct size and allow you to modify the size of the pictures if necessary before assembling them and cutting out the shape for tracing.

Call 1-800-669-9867 if you need assistance.

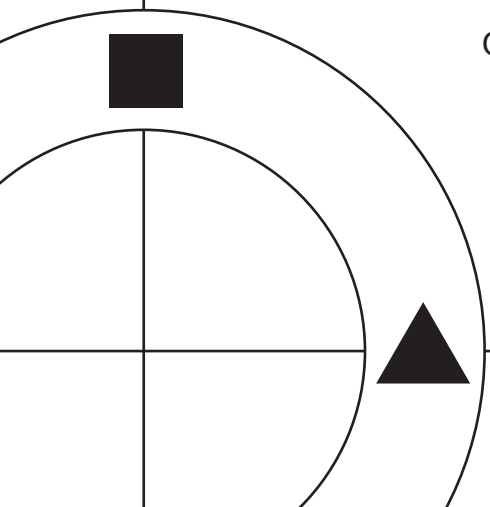

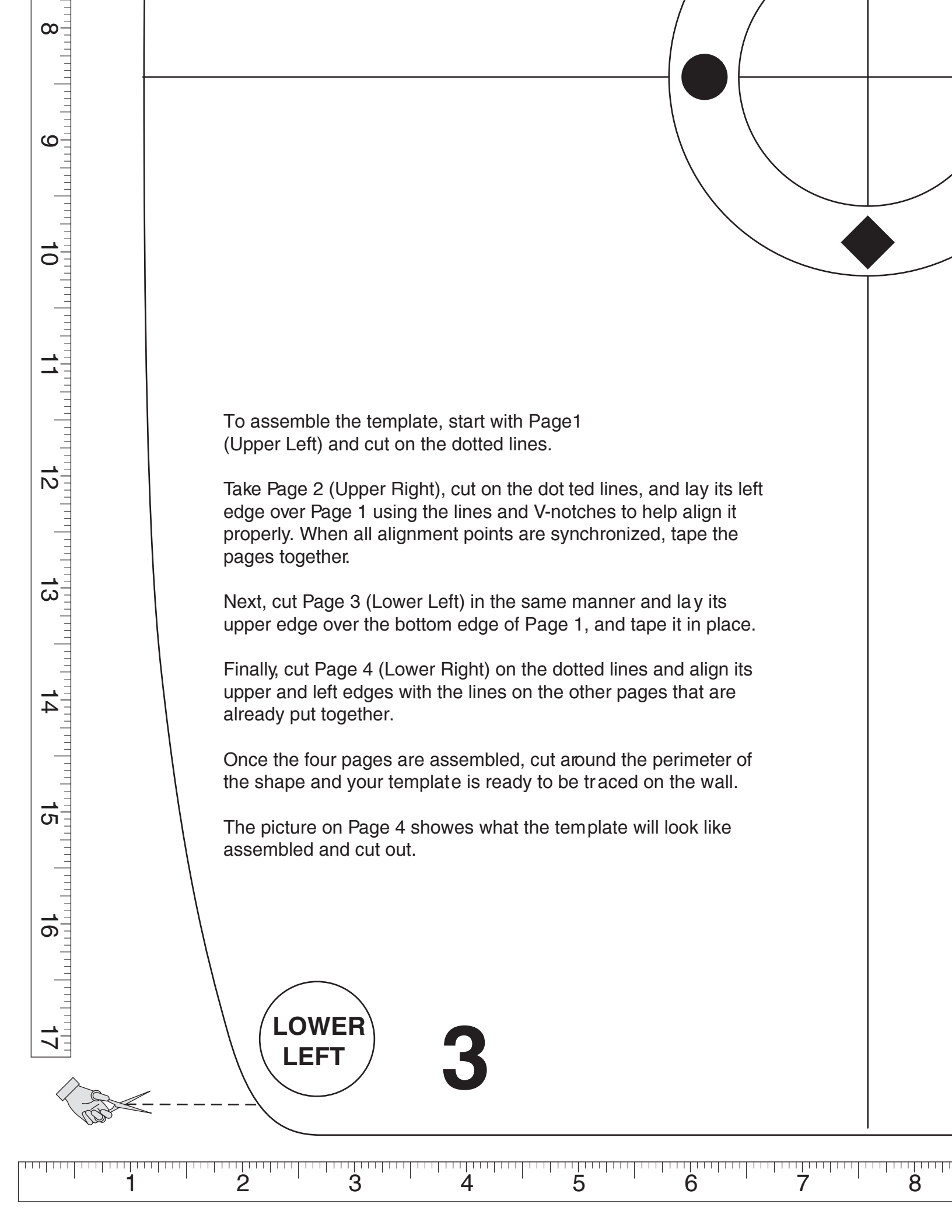

To assemble the template, start with Page 1 (Upper Left) and cut on the dotted lines.

Take Page 2 (Upper Right), cut on the dotted lines, and lay its left edge over Page 1 using the lines and V-notches to help align it properly. When all alignment points are synchronized, tape the pages together.

Next, cut Page 3 (Lower Left) in the same manner and lay its upper edge over the bottom edge of Page 1, and tape it in place.

Finally, cut Page 4 (Lower Right) on the dotted lines and align its upper and left edges with the lines on the other pages that are already put together.

Once the four pages are assembled, cut around the perimeter of the shape and your template is ready to be traced on the wall.

The picture on Page 4 shows what the template will look like assembled and cut out.

**LOWER
LEFT**

3

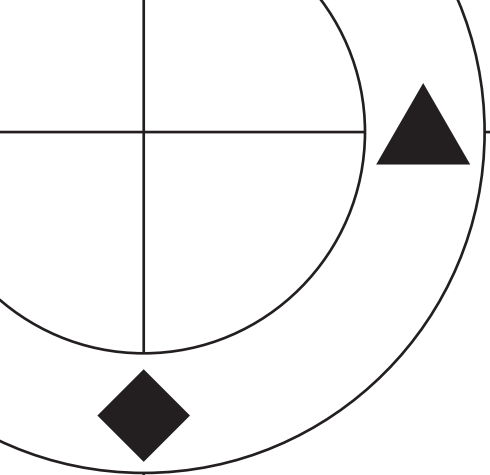

Here is what the template should look like after it has been assembled and cut out.

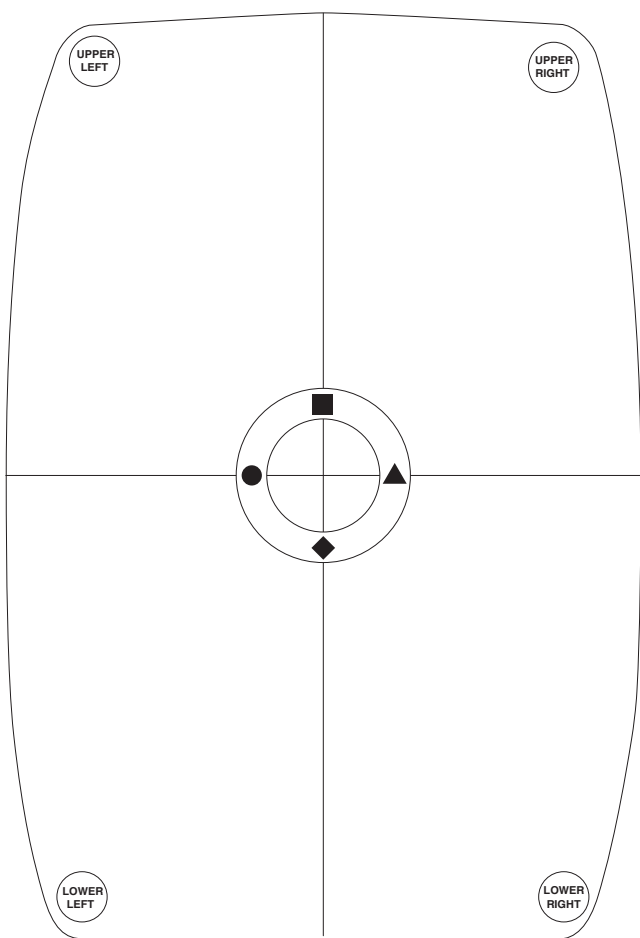

4

